

The following features are available in this PDF document.



Quick Keyword Search

Enter the keyword in the search box and hit the search button



Quick Jump between Chapters

Click the title of a specific chapter on the Contents to jump to it

*Reading software such as Adobe Reader is needed to support the functions above.



CRANE-M 3S

User Guide

Contents

□ Product List	
Product List	1
□ Get to Know CRANE-M 3S	
Get to Know CRANE-M 3S	3
□ Battery and Charging	
Battery and Charging	4
□ Mounting and Balancing	
Mounting the Tripod	5
Mounting the Camera	5
Mounting the Smartphone	9
Mounting the Action Camera	10
Balancing	12
□ How to Use CRANE-M 3S	
Button Description	14
Touchscreen Introduction	15
Touchscreen Menu	16
Motor Torque Adjustment	18
Bluetooth Shutter Control	20
Gimbal Modes Description	21
Manual Reposition	25
□ How to Use the App	
Download the App	26
How to Connect	26
ZY Play Feature Description	28

<input type="checkbox"/> Firmware Upgrade & Calibration	
Circumstances When Calibration Is Needed	29
Six-side Calibration	29
Motor Fine-tuning	32
Firmware Upgrade	32
<input type="checkbox"/> Product Specifications	
<input type="checkbox"/> Disclaimer and Warning	
Reading Tips	36
WARNING	37
Safe Operation Guidelines	37
<input type="checkbox"/> Warranty Card	
Warranty Period	38
Warranty Exclusions	38
Warranty Claim Procedure	38
<input type="checkbox"/> Contact Card	

Product List

Before using this product, please check carefully that all the following items are included in the product package. In case that any item is found missing, please contact ZHIYUN or your local selling agent.



CRANE-M 3S x 1

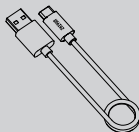

USB Type-C Cable x 1

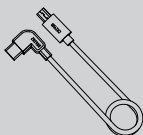
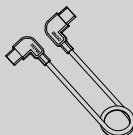
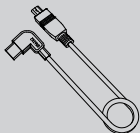
Type-C to Micro USB LN-MBUC-B02
Camera Control Cable x1Type-C to Type-C USB LN-UCUC-D07
Camera Control Cable x1Type-C to Multi USB LN-UCUS-C02
Camera Control Cable x1

Tripod x1*



Tripod x1**



Phone Clamp x1**



Backpack x1**

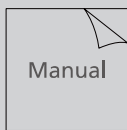

Quick Start Guide x1

Items marked “**” are included in CRANE-M 3S.

Items marked “***” are included in CRANE-M 3S COMBO.

Get to Know CRANE-M 3S

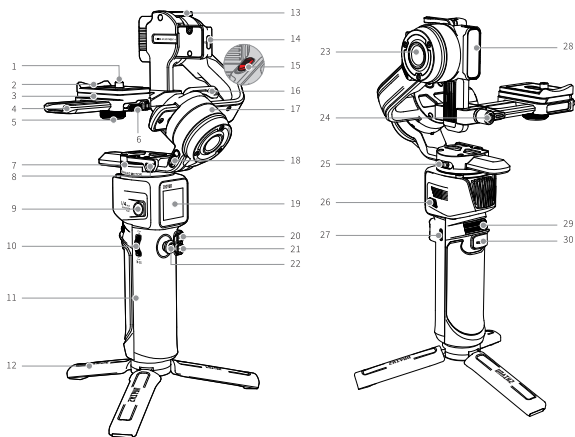

1. 1/4" Camera Installation Screw
2. Quick Release Plate
3. Quick Release Plate Leveling Base
4. Level Mount
5. Leveling Base Lock Screw
6. Quick Release Plate Safety Lock
7. Pan Axis Motor
8. Pan Axis Latch
9. 1/4" Threaded Hole
10. Fill Light Control Wheel
11. Gimbal Handle
12. Tripod
13. Tilt Axis Latch
14. Camera Control/Charging Port
15. Tilt Axis Lock Switch
16. Roll Axis Latch

17. Roll Axis Motor
18. Roll Axis Lock Switch
19. Touchscreen
20. Mode Switch
21. Photo/Video Button
22. Joystick
23. Tilt Axis Motor
24. Level Mount Lock Screw
25. Pan Axis Lock Switch
26. Power Button
27. Type-C Charging/Firmware Upgrade Port
28. Fill Light
29. Adjustment Wheel
30. Trigger Button

Battery and Charging

CRANE-M 3S is equipped with built-in battery. When using CRANE-M 3S for the first time, please fully charge the battery to activate it and to ensure the proper function of the gimbal.

Charging method: Use provided USB Type-C cable to connect the USB charger (not provided, recommend chargers that meet the USB Power Delivery Specification, supports 12W at most) to the charging port of CRANE-M 3S.

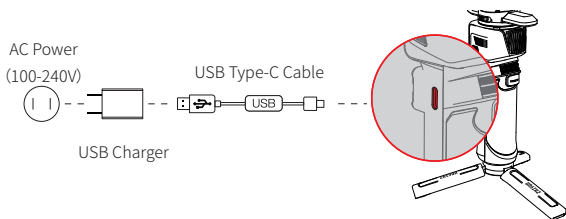

- ① USB charger is not provided.
- ② Please power off CRANE-M 3S to charge.

Mounting the Tripod

Mount the tripod to the bottom of the CRANE-M 3S handle, then unfold the tripod and place the CRANE-M 3S on a flat surface.

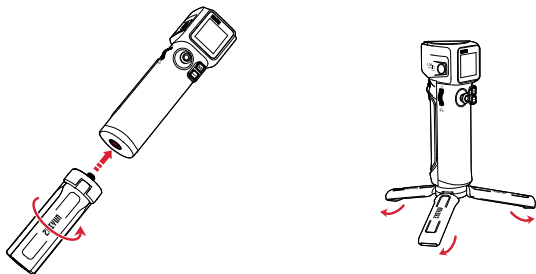

Mounting the Camera

- ① Please mount the camera before powering on CRANE-M 3S and balance the gimbal. Do not power on CRANE-M 3S when there's no camera mounted on it.
- ② Before mounting the camera, make sure it is prepared ahead of time. Remove the lens cap and make sure the camera's battery and memory card are already in place.
- ③ Each axis of the gimbal is equipped with a lock switch. You can use these lock switches to lock the axes for convenient installation and storage. The storage state is the default state. Please toggle the lock switch to unlock the three axes, expand the gimbal as shown in the image, and lock the axes again for convenient camera installation.

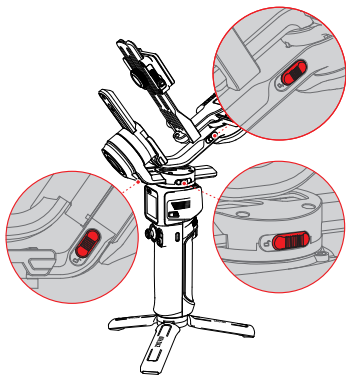

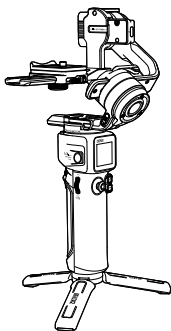

Locked state for storage

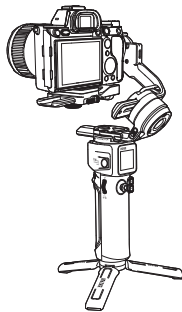
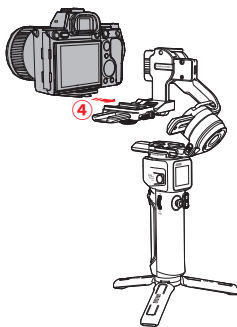
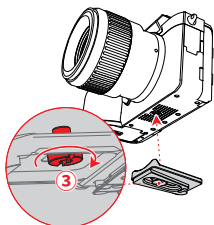
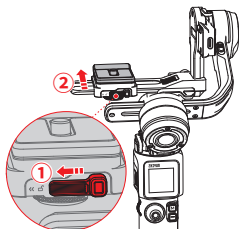

Locked state for installation

1. Hold down the quick release plate safety lock ① and remove the quick release plate from the quick release plate leveling base ②, then install the camera onto the quick release plate ③. Install the camera and quick release plate as a whole onto the leveling base ④, and the quick release plate safety lock will automatically lock.



-  To remove, push the quick release plate safety lock to the unlock position ①, and the camera and quick release plate assembly can be removed as a whole ②.

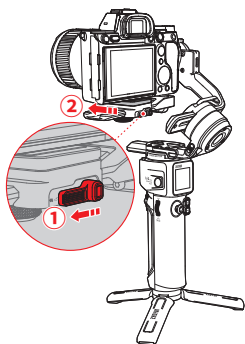

2. Connect the camera control cable to the camera control port and the camera control/charging port of the gimbal.

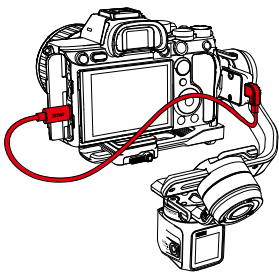

-  There are three camera control cables: Type-C to Multi USB/Type-C to Type-C USB / Type-C to Micro USB. Choose the correct cable corresponding to the USB port type of the camera. For compatibility details, please visit the official website of ZHIYUN (www.zhiyun-tech.com) and check the CRANE-M 3S Camera Compatibility List.

Mounting the Smartphone

Hold down the quick release plate safety lock ① and remove the quick release plate from the quick release plate leveling base ②, then install the phone onto the phone clamp ③. Install the phone and phone clamp as a whole onto the quick release plate ④, and then install the entire assembly onto the quick release plate leveling base ⑤.

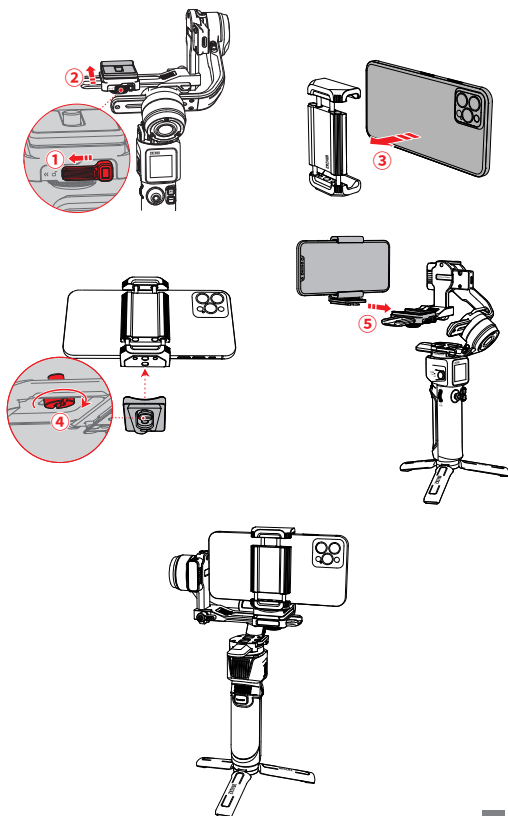

Mounting the Action Camera

Hold down the quick release plate safety lock ① and remove the quick release plate from the quick release plate leveling base ②, then install the action camera onto the camera base (not provided) ③. Install the action camera and base as a whole onto the quick release plate ④, and then install the entire assembly onto the quick release plate leveling base ⑤.

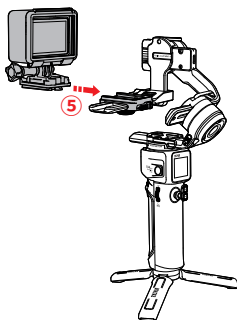
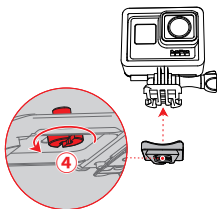
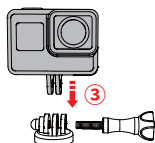
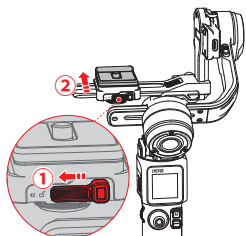

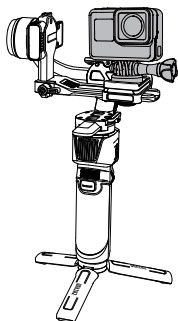

- 💡 CRANE-M 3S only provides stabilization for smartphones and action cameras. Button controls are not supported.

Balancing

1. Horizontal Balance of the Tilt Axis

Unlock the tilt axis arm ① and loosen the tilt axis latch ② . Push the camera to move forward or backward ③ until the camera is steady and is at almost level with the ground ④ . Tighten the latch ⑤ .

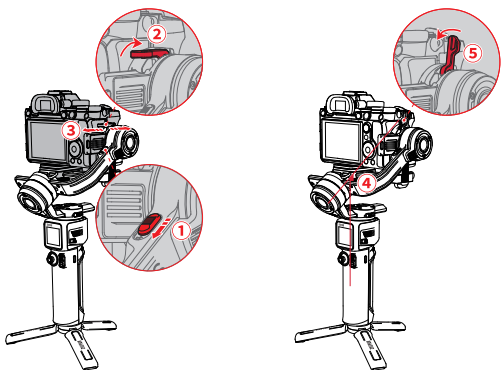

2. Vertical Balance of the Tilt Axis

Unlock the tilt axis arm, make the lens face up, loosen the level mount lock screw ① . Push the whole level mount to move forward or backward ② . Push until the camera can stay still with the lens facing up (i.e.the camera stays still and vertical to the ground) ③ . Complete this step by tightening up the screw ④ .

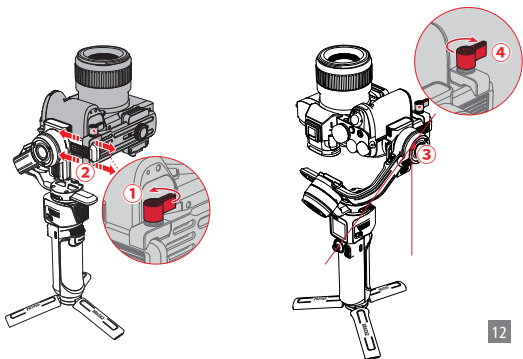

3. Roll Axis Balance

Unlock the roll axis ①, loosen the roll axis latch ②, push the roll axis arm to move left or right ③ until the camera can stay still and horizontal to the ground (as shown below) ④. Complete this step by tightening up the latch ⑤.

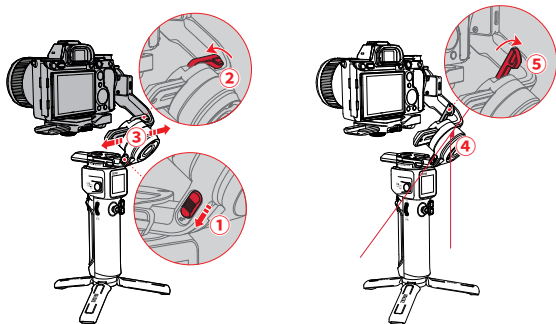

4. Pan Axis Balance

Unlock the pan axis ①, loosen the pan axis latch ②, hold and slightly tilt the handle, push the pan axis to move left or right ③ until the pan axis can stay still in any position. Complete this step by tightening up the pan axis latch ④.

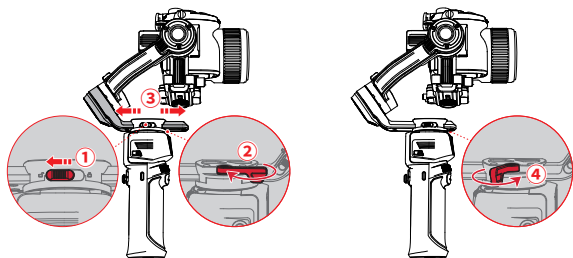

💡 After balancing CRANE-M 3S, the motor torque needs to be adjusted for proper function. For the adjustment details, please see the methods introduced in "Motor Torque Adjustment".

Button Description



Power Button

Press and hold: Power on/off



Mode Switch

Single press: Switch gimbal modes (PF-L-F)

Double press: Switch gimbal modes (POV-V)

Press and hold: Sleep mode/wake mode for the gimbal motor



Photo/Video Button

Half press: Activate auto-focus on certain cameras.

Long press: Take a photo.

Single press: Start/stop filming a video.

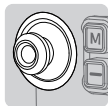

Joystick

Push the joystick up/down/left/right to control the gimbal to rotate.



Fill Light Control Wheel

Single press: When the fill light is on, press to switch between fill light brightness/color temperature level.

Scroll: When the fill light is on, scroll to adjust fill light brightness/color temperature level.

Long press: Turn on/off the fill light.



Trigger Button

Single press: Switch to customized gimbal mode (Follow mode by default)/Return to the previous mode.

Double press: Gimbal reposition.

Triple press: 180° rotation for the pan axis motor

Long press: Enter Go mode. Release to return to the previous mode. When in the portrait mode, long press to lock the gimbal. Motors of three axes won't move with the handle. Release to unlock the gimbal and the motors of tilt axis and roll axis will move with the handle.



Adjustment Wheel

Scroll: Adjust parameters customized in the touchscreen menu (aperture, shutter, ISO, digital focus/zoom, roll axis, tilt axis, pan axis).

Touchscreen Introduction

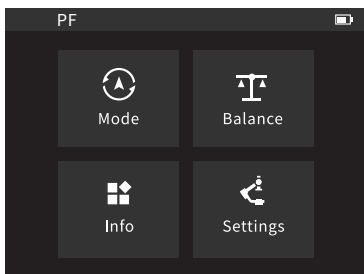

Main page (set as default)

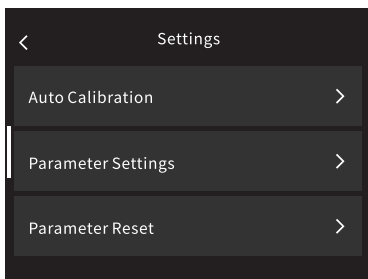

Gimbal Settings Interface

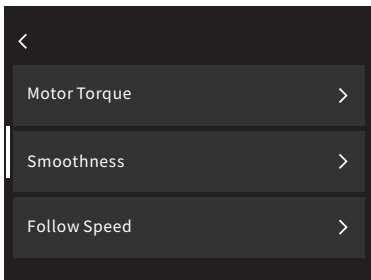

Parameter Settings Interface

 Swipe right at the left edge of the screen to return to the previous menu.

Touchscreen Menu



Mode:

For selecting gimbal modes. Available modes are: Pan Follow Mode (PF)/Lock Mode (L)/POV Mode (POV)/ Follow Mode (F)/Go Mode (GO)/Vortex Mode (V)/Portrait Mode



Balance:

To see the balance status of three gimbal axes.



Info:

1. Language: Switch the language of the touchscreen menu (simplified Chinese/English)
2. Device Info: See the device information such as device name/device model/SN/firmware version
3. Factory Reset: Tap to factory reset the gimbal.



Settings:

1. Auto Calibration: To perform auto-calibration after the balancing is finished.
2. Parameter Settings: Sets the motor torque/smoothness/follow speed/joystick speed/deadband of the gimbal.
3. Parameter Reset: Reset the parameters to default.
4. Control Wheel: Customize the control wheel. Can be customized to control aperture/shutter/ISO/zoom/focus/roll axis/tilt axis/pan axis
5. Control Wheel Setting: Sets the orientation/sensitivity of control wheel parameter adjustment.
6. Trigger Button: Customize the gimbal mode when pressing the trigger button once.
7. Bluetooth Shutter Control: Connect the camera Bluetooth to wirelessly control the camera.
8. Motor Fine-tuning: Fine-tune the roll axis/tilt axis angle of the gimbal.
9. Shooting: Set the shooting features in the gimbal (Panorama/Timelapse/Motionlapse/V Mode)

Motor Torque Adjustment

After balancing CRANE-M 3S, the motor torque needs to be adjusted for proper function. You can adjust the motor torque according to the weight of your camera and lens, so that the CRANE-M 3S can be used in its ideal state. Following are two methods for adjustment. It is recommended to use auto-calibration.

1. Auto calibration:

Auto calibration will adjust the motor torque according to the weight of the carried camera and lens.

Operation steps:

Select "Settings" - "Auto Calibration", tap to enter calibration. You can see the calibration progress on the screen.

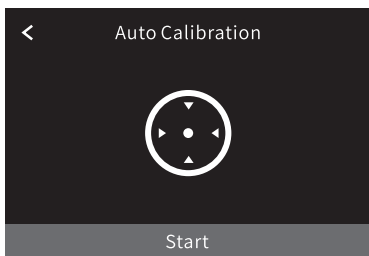

💡 When performing auto-calibration, please make sure that the gimbal is balanced, the three axes are unlocked and the gimbal is straightly put on a flat surface. Please don't touch the gimbal when calibrating.

2.Motor Torque:

Three levels (Low/Medium/High) are provided based on the mainstream lens combo weight in the market. Select the appropriate level according to the weight of the carried camera and lens.

Operation steps:

Select "Settings" - "Parameter Settings" - "Motor Torque" to enter motor torque setting interface.

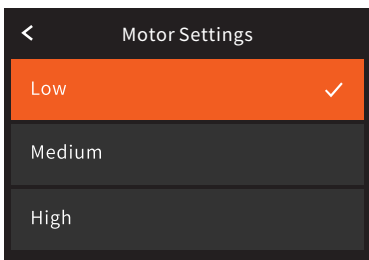

- ① If the motor torque is too low/high for the payload, the camera will shake and affect the gimbal performance. Please choose proper motor torque.
- ② When setting the motor torque, please make sure that three gimbal axes are unlocked and the gimbal is straightly put on a flat surface.
- ③ It is recommended to use auto-calibration. If the gimbal is not yet in the ideal state after the auto-calibration, you can use the customized adjustment or choose the level of the motor torque to be high/medium/low.
- ④ When the camera lens is changed, please balance the gimbal again and adjust the motor torque with the methods above.

Bluetooth Shutter Control

CRANE-M 3S supports Bluetooth shutter control, which allows you to wirelessly control the camera shutter without connecting a camera control cable. Before connecting the camera Bluetooth to CRANE-M 3S, please turn on the camera's Bluetooth and enter pairing mode. Then tap the "Gimbal Setting" in the touchscreen menu, select "Bluetooth Shutter Control", make sure the camera Bluetooth is turned on and tap to confirm. CRANE-M 3S will then automatically search for the camera Bluetooth name. Select the Bluetooth name that needs to be connected, and finally confirm the connection on the camera.

- ① After CRANE-M 3S and the camera complete pairing and successfully connect Bluetooth for the first time, they can automatically connect to Bluetooth next time.
- ② When CRANE-M 3S and the camera are connected through both camera control cables and Bluetooth at the same time, the gimbal prioritizes controlling the camera function through the camera control cable.
- ③ After CRANE-M 3S and the camera are connected via Bluetooth, the Bluetooth connection can be disconnected in the Bluetooth shutter control menu.
- ④ For specific camera models that support Bluetooth control in CRANE-M 3S please visit the ZHIYUN official website www.zhiyun-tech.com to check the "CRANE-M 3S Camera Compatibility List" for the latest information.

Gimbal Modes Description

💡 Motors circled in red are free to move in line with the movement of the gimbal handle while motors circled in grey are locked.

Pan Follow mode (PF):

The tilt axis and roll axis motors are locked, and the camera rotates with the handle while panning horizontally. Push the joystick up/down to control the tilt axis angle, and push it left/right to control the pan axis of the camera.

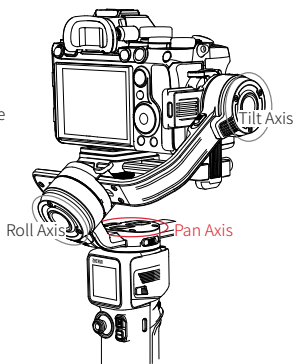

Lock mode (L):

All three motor angles are locked, and the camera orientation will not move with the rotation of the handle. Push the joystick up/down to change the tilt angle of the camera and left/right to change the horizontal orientation of the camera.

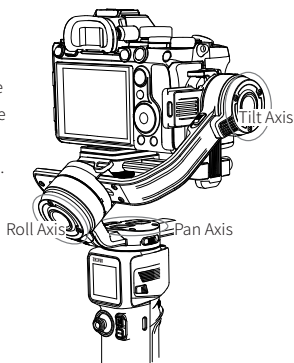

Follow mode (F):

The roll axis motor is locked, and the tilt axis and pan axis motors follow the rotation of the handle. Push the joystick up/down to change the tilt angle of the camera and left/right to change the horizontal orientation of the camera.

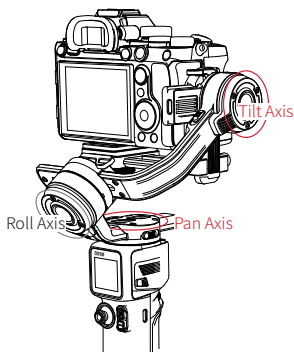

Point of View mode (POV):

All three motors move when the handle is rotated. Push the joystick up/down to change the tilt angle of the camera and left/right to change the horizontal orientation of the camera.

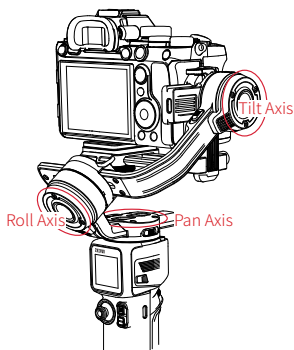

Vortex mode (V):

The tilt axis motor rotates upward by 90°, and the tilt axis, roll axis, and pan axis motors follow the rotation of the handle. Push the joystick to the left/right to control the rotation of the pan axis.

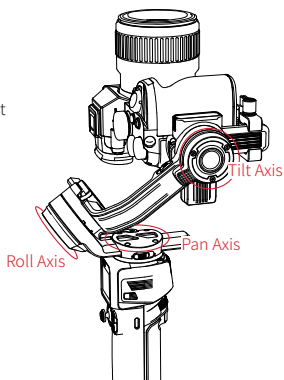

Go Mode (GO):

The roll axis motor is locked, and the tilt axis and pan axis motors quickly follow the rotation of the handle. Push the joystick up/down to change the tilt angle of the camera and left/right to change the horizontal orientation of the camera.

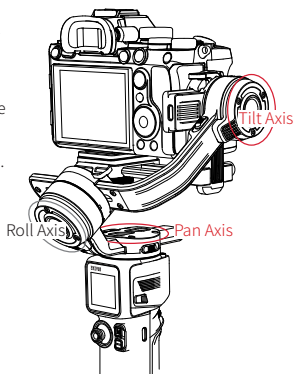

Portrait mode

The tilt axis motor rotates upward by 90° and the pan axis rotates counterclockwise by 90° . You can enter this mode for vertical filming.

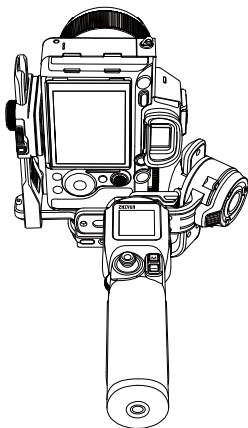

Manual Reposition

In Pan Follow mode (PF) and Lock mode (L), the camera can be rotated by a certain angle by hand. Hold it for 2s and the camera angle will be fixed at that angle after you release the camera.

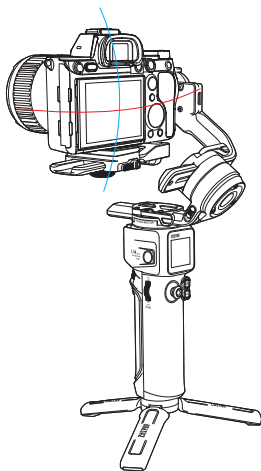

Download the App



Scan the QR code on the left (Android 5.0 and above, iOS 9.0 and above required) or search "ZY Play" in App Store or Google Play to download.

- ① ZY Play is an app dedicatedly designed for CRANE-M 3S. When activated CRANE-M 3S via "ZY Play", you can also use it for firmware upgrades, virtual joystick control, six-side calibration, etc.
- ② ZY Play is subject to updates without notice. Please always refer to the latest version.

How to Connect

1. Power on CRANE-M 3S and turn on Bluetooth on the smartphone.
2. Launch the "ZY Play" app. Select the CRANE-M 3S page and tap to connect. Select the Bluetooth name of your CRANE-M 3S to connect (the CRANE-M 3S Bluetooth name can be found on the side of the tilt axis USER ID: XXXX).
3. If the CRANE-M 3S is being used for the first time, you need to activate the gimbal via "ZY Play" to use the advanced features in the app. Internet connection is required.
4. After the activation succeeds, you can enter the feature interface of ZY Play App.

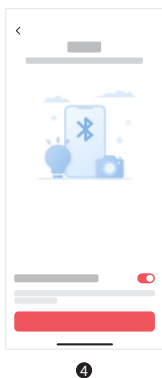
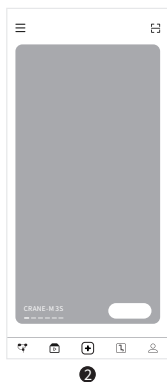
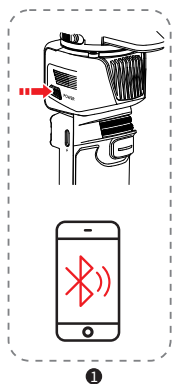

ZY Play Feature Description



💡 For more details of the “ZY Play” app features, please visit the official website of ZHIYUN (www.zhiyun-tech.com) and watch CRANE-M 3S video tutorials.

Circumstances When Calibration Is Needed

Calibrate the gimbal as needed.

Calibration Reason	Calibration Method
1. Slight deviation is found in the level position after the initialization of the gimbal. 2. The gimbal has not been used for a long time. 3. The gimbal undergoes significant temperature differences in operation environments.	Six-side Calibration
Slight deviation is found in the tilt or roll angle in level position after six-side calibration of the gimbal.	Motor fine-tuning

Six-side Calibration

1. Six-side calibration via APP:

According to the method introduced in "How to Use the App", please connect the gimbal to the APP, and enter "Settings" - "Six-side Calibration", then conduct the six-side calibration according to the prompt.

2. Six-side calibration via "Zhiyun Gimbal Tools":

Power on the gimbal and enter standby mode. Connect the charging/upgrade port of the gimbal to the computer with the Type-C USB cable, Open "Zhiyun Gimbal Tools", click "open" on the top and click "calibration" on the bottom. Please conduct the process according to the following steps. A "√" mark will appear after the calibration is completed.

- 💡 ① Please refer to the six-side calibration steps below. After the calibration is completed, please restart the gimbal.
- ② In simple terms, six-side calibration is to place all six sides of the quick release plate vertically to a level surface respectively.

Step 1

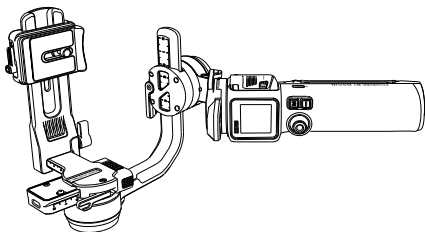

Step 2

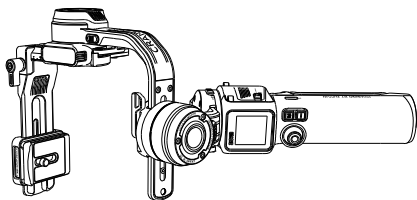

Step 3

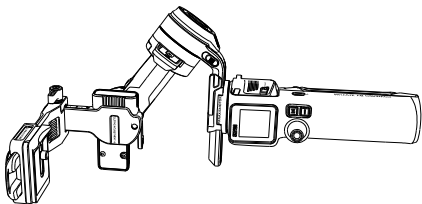

Step 4

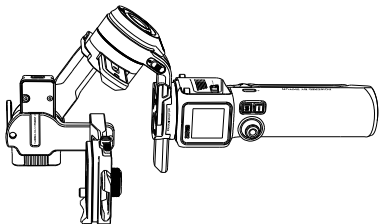

Step 5

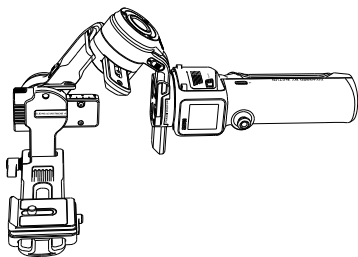

Step 6

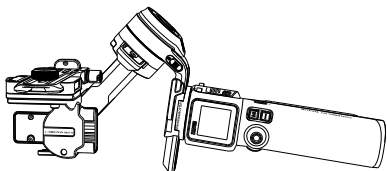

Motor Fine-tuning

Select the “Settings” in the touchscreen menu and select “Motor fine-tuning” to enter the tilt axis/roll axis angle fine-tuning interface.

Firmware Upgrade

You can use “Zhiyun Gimbal Tools” or “ZY Play” App to upgrade the firmware of CRANE-M 3S.

Method One:

1. Visit the official website of ZHIYUN (www.zhiyun-tech.com), go to the CRANE-M 3S product page, click “Download”, find the USB driver, the calibration upgrade tool and the firmware and download. (USB drivers are not required for Mac OS systems)
2. Install the driver, unzip the firmware for the documents with the “.ptz” file extension.
3. Connect the Type-C charging/upgrade port of CRANE-M 3S to the computer with the Type-C USB cable, power on CRANE-M 3S.
4. Open “Zhiyun Gimbal Tools”, click “Open”, click “Firmware Upgrade”. Click “Browse” under “Path” to select the latest firmware downloaded (with the “.ptz” file extension), and click “Upgrade” at the bottom to upgrade firmware.

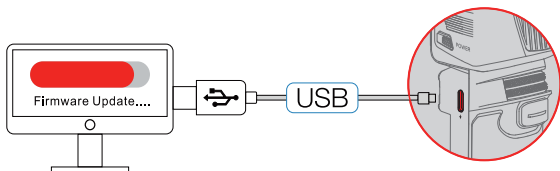

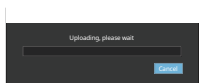
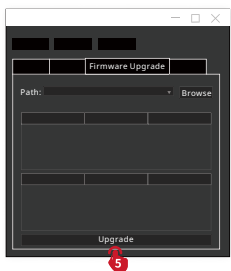
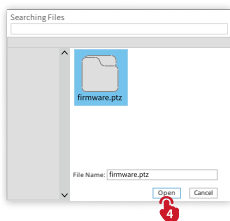
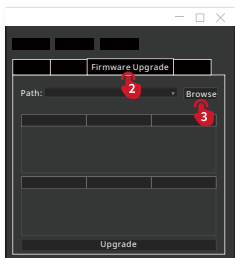
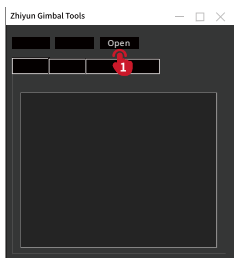

Method Two:

When CRANE-M 3S is connected to “ZY Play” app, if a firmware update prompt pops up on the app, please follow the instructions to upgrade. Internet connection is required. To know how you can connect CRANE-M 3S to “ZY Play”, please check the method introduced in "How to Use the App".

- ① When upgrading with Method 1, please wait until the screen displays that the upgrade is finished, then you can plug out the USB Type-C cable.
- ② Before upgrading the firmware, please ensure that the CRANE-M 3S has more than 50% power remaining. You will not be able to exit the app interface or access in the background during the upgrading process. Pay attention to the prompts on the app.

Product Model: CR127

Item	Min.	Standard	Max.	Remark
Operation Voltage	9.6V	11.1V	12.6V	
Operation Current	135mA	-	4000mA	
Output Voltage (Camera Control Port)	-	5V	-	
Output Current (Camera Control Port)	-	1A	-	
Tilt Mechanical Range	-	305°	-	
Roll Mechanical Range	-	314°	-	
Pan Mechanical Range	-	360°	-	
Controllable Tilt Angle	-45°	-	160°	
Controllable Roll Angle	-30°	-	30°	
Controllable Pan Angle	-	360°	-	
Operation Temperature	-10°C	25°C	50°C	
Battery Capacity	-	1150mAh	-	
Battery Runtime		7H 30min		Lab Data 1
Charging Time		2H		Lab Data 2
Gimbal Net Weight		705g	-	With quick release plate
Tripod Weight		53g		
Gimbal Size (Folded)		184.2*163.5*74.5mm		Without tripod
Gimbal Size (Expanded)		265.6*141.2*152.2mm		Without tripod

Item	Min.	Standard	Max.	Remark
Bluetooth		Bluetooth 5.0		
EIRP		< 10dBm		
Operation Frequency		2.4GHz		
Camera Charging		Able to charge 5V / 1A cameras		
1/4" Rosette Mount Screw Thread Carry Weight		Carry weight \leq 1000g, Arm \leq 100mm		
Touchscreen Size		1.22inch		

Lab Data 1: The above data is collected at a specified temperature of 25°C . The CRANE-M 3S is fully charged and mounted with Sony α 1+FE 24 mm F1.4 GM. The CRANE-M 3S is properly balanced and put on a flat surface. The maximum runtime is 7h30min. The actual duration of use may vary depending on the length of time CRANE-M 3S is used, the number of times the battery is charged and discharged, and the battery activity. The longer the CRANE-M 3S is used, the more times the battery is charged and discharged, and the lower the battery activity, the shorter the duration of use will be.

Lab Data 2: This test is conducted with a 9V-12W PD Fast Charge at a specified temperature of 25°C . The charging time is 2h. The actual charging time varies with environmental factors. In addition, the lower the temperature, the longer the charging time.

All the data in this guide is collected from internal experiments of ZHIYUN laboratories. Under different scenarios, the above data is subject to a margin of error. Please refer to actual use of this product.

Thank you for purchasing this product. The information contains herein affects your safety, legitimate rights and obligation. Please read this instruction carefully to ensure proper configuration before use. Failure to read and follow this instruction and warnings herein may result in serious injury to you or bystanders, or damage to your device or property. Guilin Zhishen Information Technology Co., Ltd (hereinafter referred to as "ZHIYUN") reserves all rights for final explanation on this instruction and other documents related to the product. The information is subject to update without notice. Please visit www.zhiyun-tech.com to obtain the latest product information.

By using this product, you hereby signify that you have read this document carefully and that you understand and agree to abide by the terms and conditions herein. You agree that you are solely responsible for your own conduct while using this product, and for any consequences thereof. You agree to use this product only for purposes that are proper and in accordance with all terms, precautions, practices, policies and guidelines ZHIYUN has made and may make available.

ZHIYUN accepts no liability for damage, injury or any legal responsibility incurred directly or indirectly from the use of this product. Users shall observe safe and lawful practices including, but not limited to, those set forth herein.

ZHIYUN™, TransMount™ are the trademark of Guilin Zhishen Information Technology Co., Ltd and its affiliates. All product names or trademarks referred to herein are trademarks or registered trademarks of their respective holders.

Reading Tips

Legends:  Hints and Tips

 Important

WARNING

Read the ENTIRE User Guide to become familiar with the features of this product before operating. Failure to operate the product correctly can result in damage to the product or personal property and cause serious injury. This is a sophisticated product. It must be operated with caution and common sense and requires some basic mechanical ability. Failure to operate this product in a safe and responsible manner could result in injury or damage to the product or other property. This product is not intended for use by children without direct adult supervision. DO NOT use with incompatible components or in any way otherwise as mentioned or instructed in the product documents provided by ZHIYUN. The safety guidelines herein contain instructions for safety, operation and maintenance. It is essential to read and follow all of the instructions and warnings in the User Guide, prior to assembly, setup or use, in order to operate the product correctly and avoid damage or serious injury.

Safe Operation Guidelines

1. This product is a high-precision control device. Damage may be caused to this product if dropped or subject to external force, and this may result in malfunction.
2. Make sure the rotation of the gimbal axes is not blocked by external force when this product is turned on.
3. this product is not waterproof. Prevent contacts of any kind of liquid or cleaner with the this product. It is recommended to use dry cloth for cleaning.
4. Protect this product from dust and sand during use.

Warranty Period

1. Customers are entitled to replacement or free repair service in case of quality deficits found in the product within 15 days upon receipt of the product.
2. Customers are entitled to free repair service from ZHIYUN for any product proven defective in material or workmanship that results in product failure during normal consumer usage and conditions within the valid warranty period, which is 12 months counting from the date of selling. However, warranty period varies by product component and country of purchase. Please contact our after-sales service team on ZHIYUN official website or your place of purchase for detailed warranty information.

Warranty Exclusions

1. Products subjected to unauthorized repair, misuse, collision, neglect, mishandling, soaking, accident, and unauthorized alteration.
2. Products subjected to improper use or whose labels or security tags have been torn off or altered.
3. Products whose warranty has expired.
4. Products damaged due to force majeure, such as fire, flood, lightning, etc.

Warranty Claim Procedure

1. If failure or any problem occurs to your product after purchase, please contact a local agent for assistance, or you can always contact ZHIYUN's customer service through email at info@zhiyun-tech.com or website at www.zhiyun-tech.com.
2. Your local agent or ZHIYUN's customer service will guide you through the whole service procedure regarding any product issue or problem you have encountered. ZHIYUN reserves the right to reexamine damaged or returned products.

Customer Information

Customer Name:

Phone Number:

Address:

Sales Information

Sales date:

Product Serial Number:

Distributor Name:

Distributor's Contact Number:

First Maintenance Record

Service Date:

Repairman Signature:

Cause of Problem:

Service Result:

Solved

Unsolved

Refunded/Replaced



Website



Weibo



Vimeo



Google+



Facebook
(Zhiyun Support)



Facebook
(Zhiyun Tech)



Youku



Youtube



Wechat



Instagram

Tel: +86 400 900 6868

USA Hotline: +1 808-319-6137,9:00-18:00 GMT-7,Mon-Fri

Europe Hotline: +49 (0) 61018132180,10:00-17:00 GMT+1,Mon-Fri

Web: www.zhiyun-tech.com

E-mail: info@zhiyun-tech.com

Address: 09 Huangtong Road, Tieshan Industrial Zone, Qixing District, Guilin, 541004, Guangxi, China

Certificate of Quality

This product is confirmed to meet quality standards and permitted for sale after strict inspection.

QC Inspector: _____



For full product information, please visit ZHIYUN's official website: Content on www.zhiyun-tech.com is subject to update without notice.

ZHIYUN™ is a trademark of ZHISHEN

All product names or brands referred to hereunder may be trademarks or registered trademarks of their respective holders.

Copyright © 2023 ZHISHEN. All rights reserved.

ZHIYUN-TECH.COM